

SUNTECH

flat LT [FLT2]

module 2

11' 6" > 22' 11"
350cm > 700cm

Two module with one motor & 3 rafters
max width. 22' 11"
700 cm

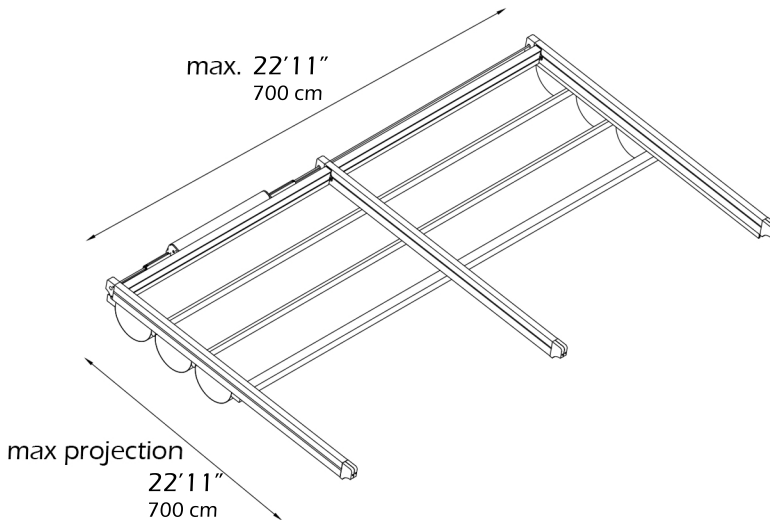

For additional technical information : Tel. 954 317 3862
www.SuntechDesigns.com