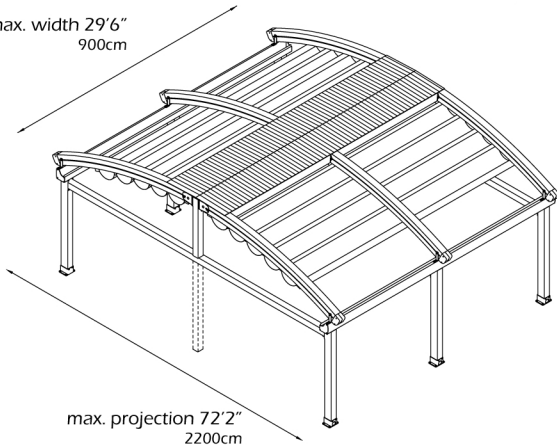

**SUNTECH****tw33 XL [TW33XL2]****module 2****14' 9" - 29' 6"**  
**450cm - 900cm**Two module with 2 motors & 6 rafters  
max. width 29'6"  
900cmmax. width 29'6"  
900cmmax. projection 72'2"  
2200cmFor additional technical information : Tel. 954 317 3862  
[www.SuntechDesigns.com](http://www.SuntechDesigns.com)